

P. 1 三角形・四角形 No. 1

1 三角形 (③)

2 正方形 (⑥) 長方形 (④) 直角三角形 (⑤)

P. 2 円をかこう No. 1

1 ① (2cm) ② (4cm)

2 ①

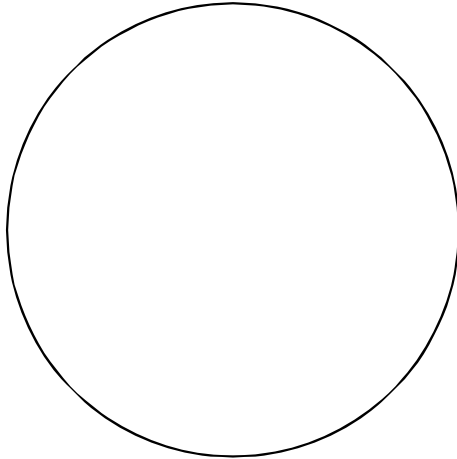

②

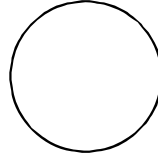

P. 3 円をかこう No. 2

1 ① (2cm) ② (6cm)

2 ①

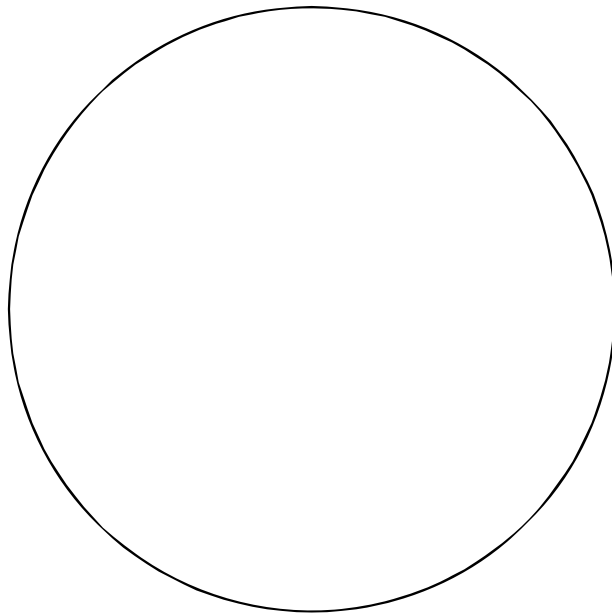

②

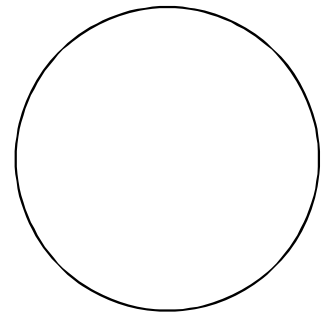

P. 4 円をかこう No. 3

①

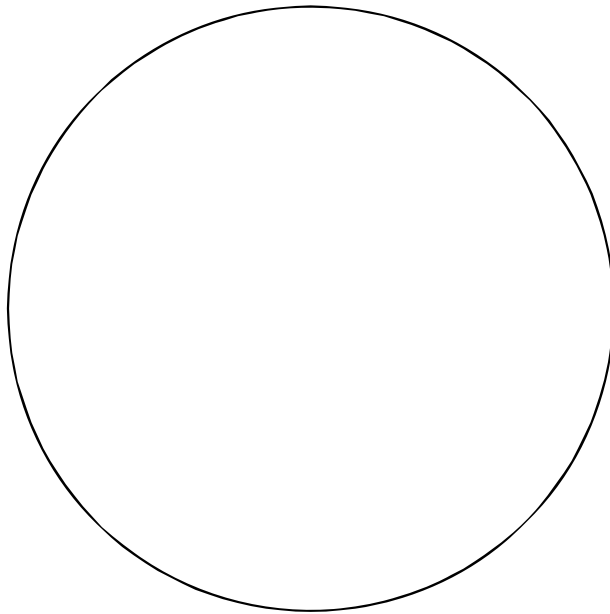

②

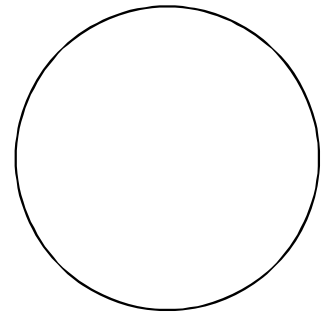

③

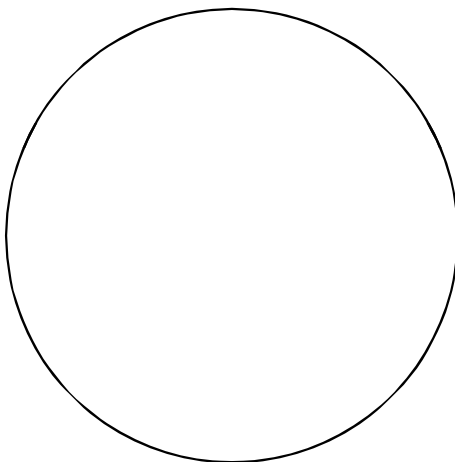

④

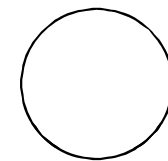

P. 5 円をかこう No. 4

1

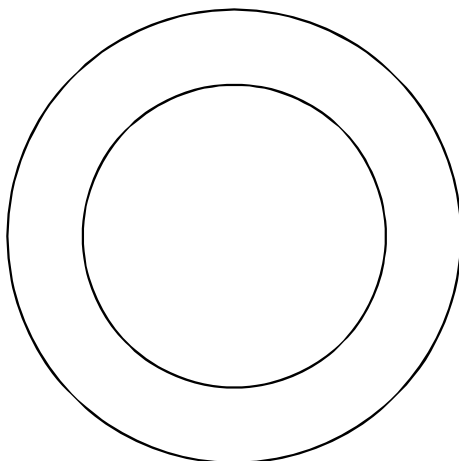

2

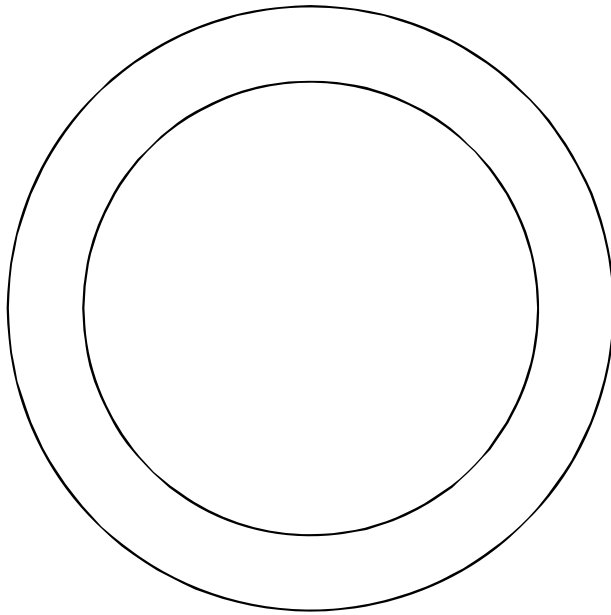

P. 6 きれいなもようをかこう No. 1

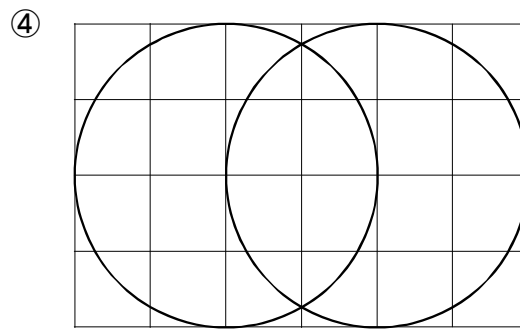
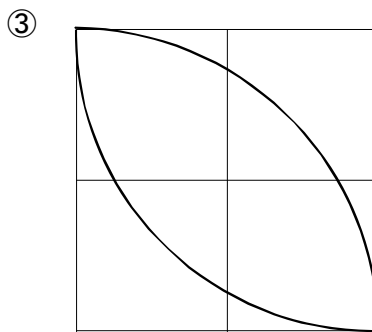
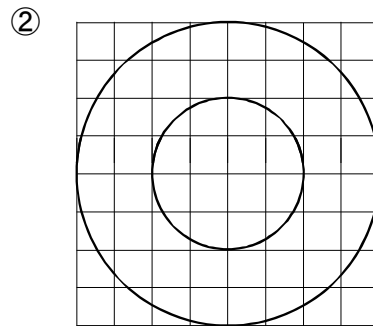
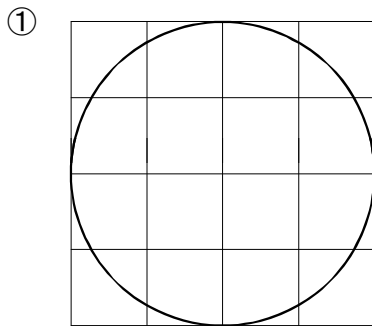

P. 7 きれいなもようをかこう No. 2

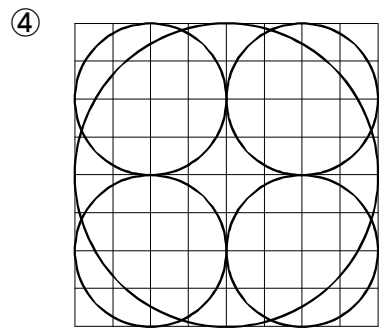
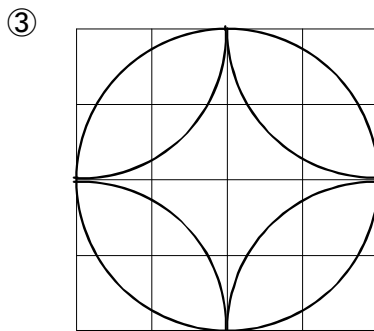
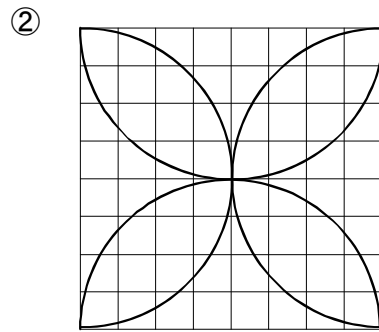
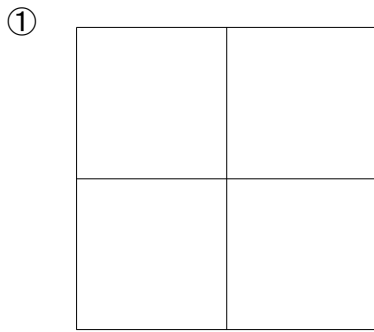

P. 8 きれいなもようをかこう No. 3

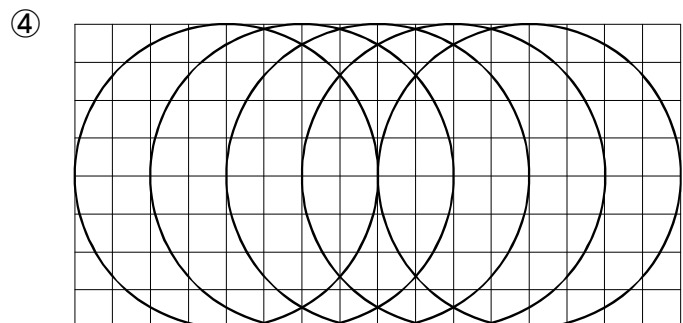
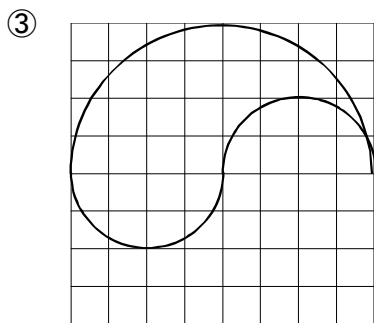
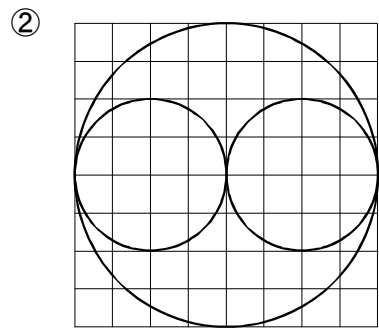
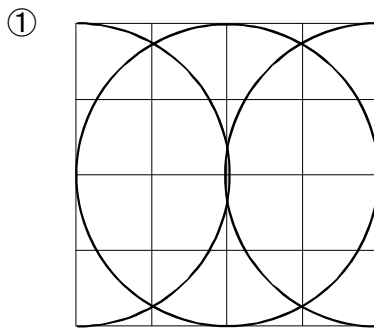

P. 9 きれいなもようをかこう No. 4

①

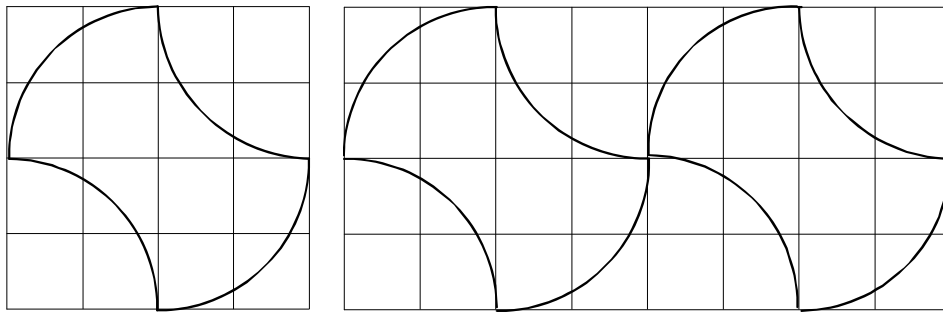

②

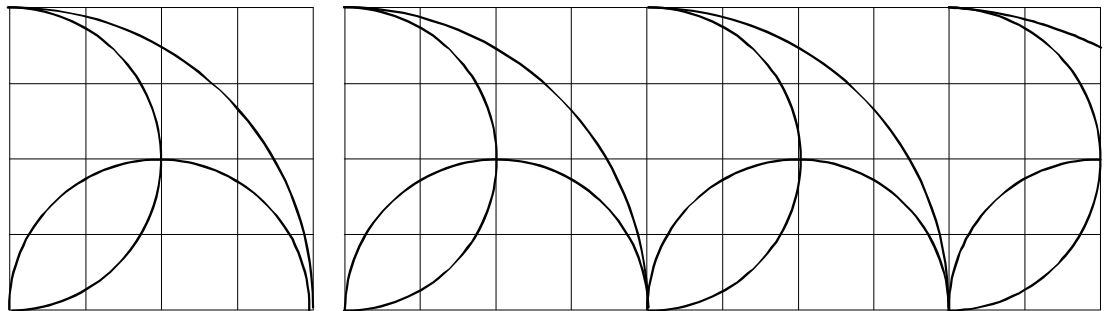

③

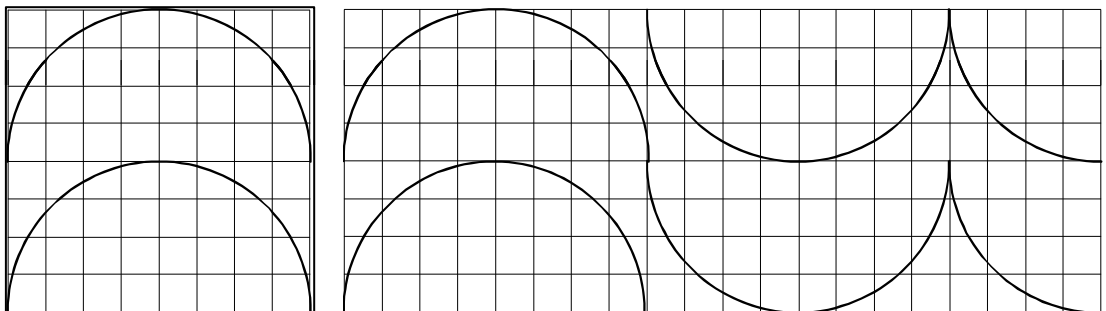

④

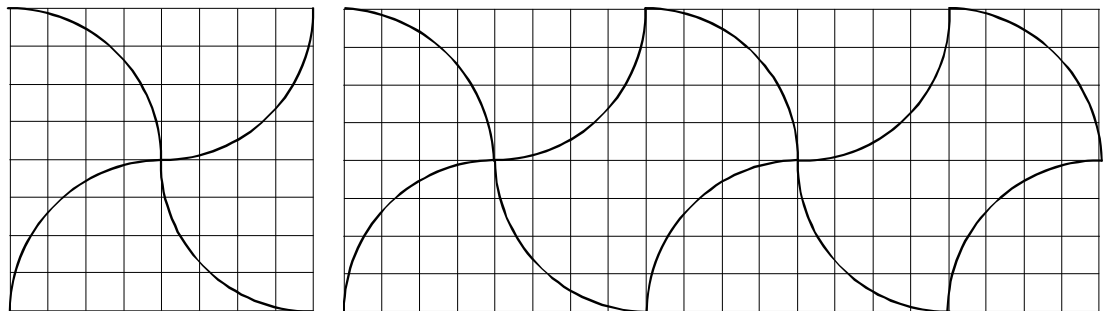

P. 10 まるい形 No. 1

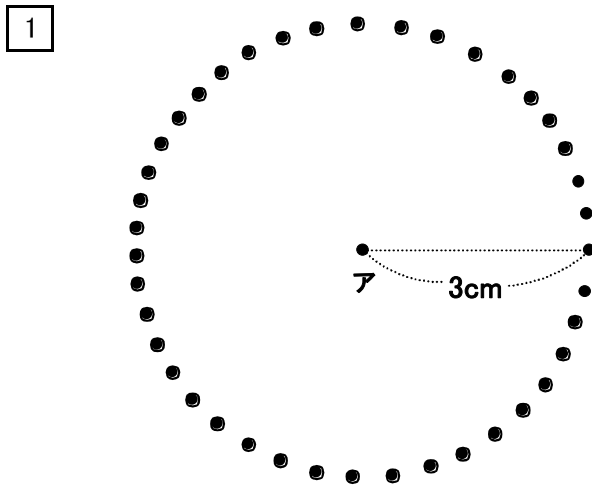

2 ① (3cm) ② (3cm) ③ (3cm)

P. 11 まるい形 No. 2

1 アエ

2 ① (6cm) ② (3cm)

P. 12 まるい形 No. 3

1 (イ) (エ)

2 ① (中心) ② (半径) ③ (直径) ④ (2cm)
⑤ (4cm)

P. 13 まるい形 No. 4

1 ① (半径) ② (中心) ③ (20cm) ④ (3cm)

2 ① (中心) ② (8cm) ③ (4cm)

P. 14 まるい形 No. 5

① 半径 (3cm) ② 半径 (1cm) ③ 半径 (2cm 5mm)
直径 (6cm) 直径 (2cm) 直径 (5cm)
④ 半径 (3cm 5mm)
直径 (7cm)

P. 15 まるい形 No. 6

1 ① (8cm) ② (24cm) ③ (5cm) ④ (8cm)

⑤ (②)

2 ① (半径) ② (直径) ③ (中心) ④ (2)

⑤ (中心)

P. 16 円の利用 No. 1

1 ①

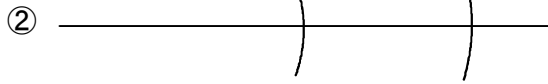
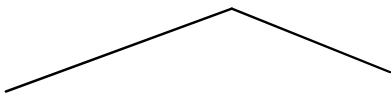

答え (②)

2 ①

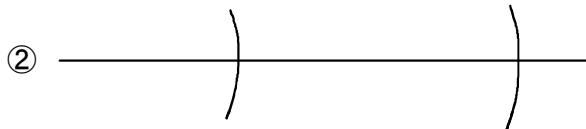
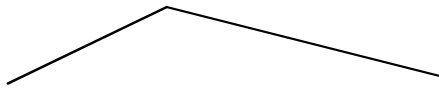

答え (②)

3 ①

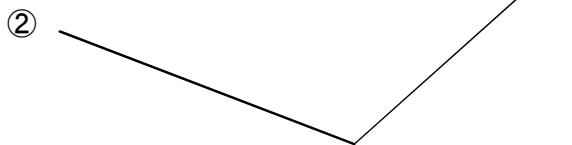
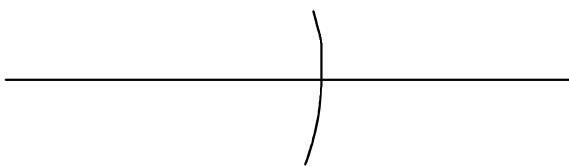

答え (②)

P. 17 円の利用 No. 2

1 ①

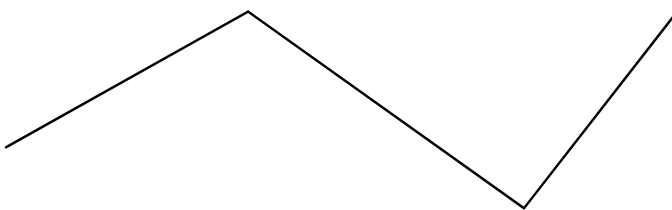

答え (①)

2 ①

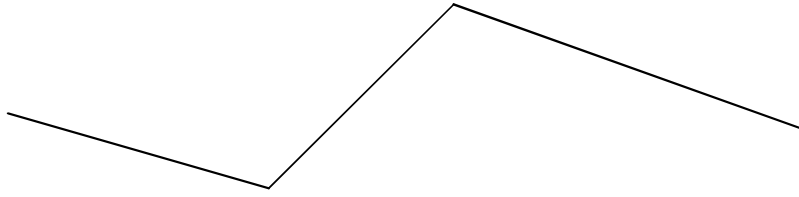

答え (②)

②

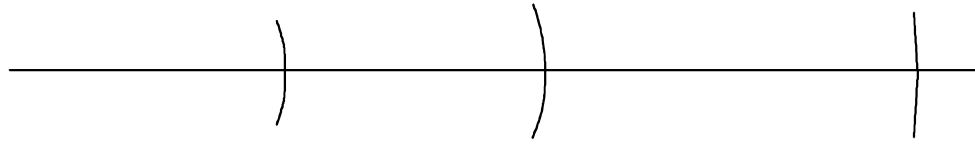

3 ①

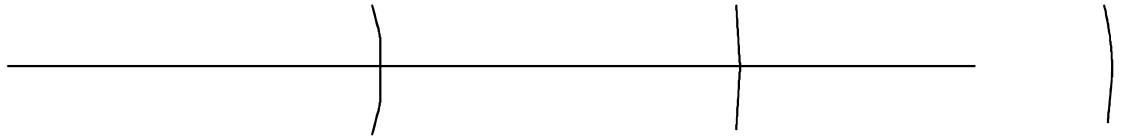

②

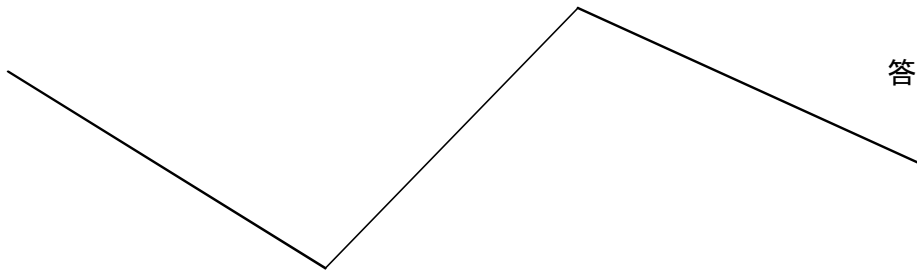

答え (②)

P. 18 円の利用 No.3

1

答え (カ)

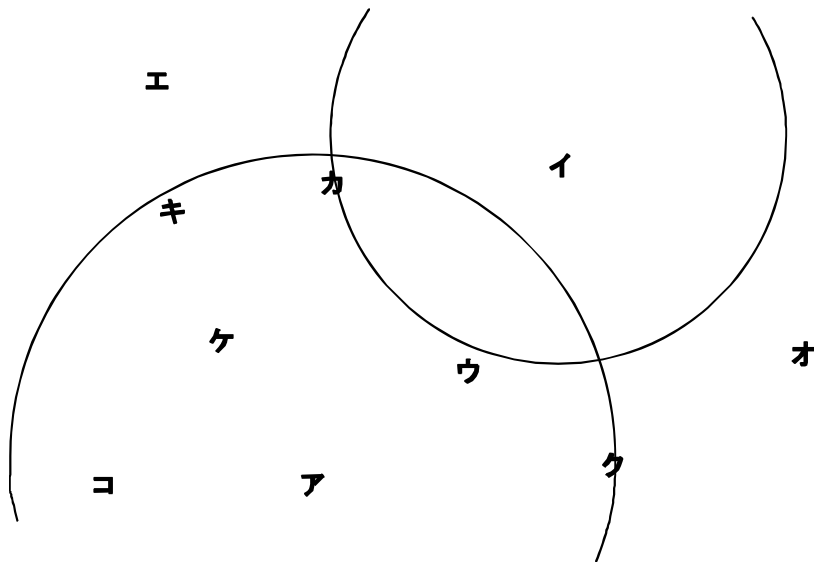

2

答え (カ)

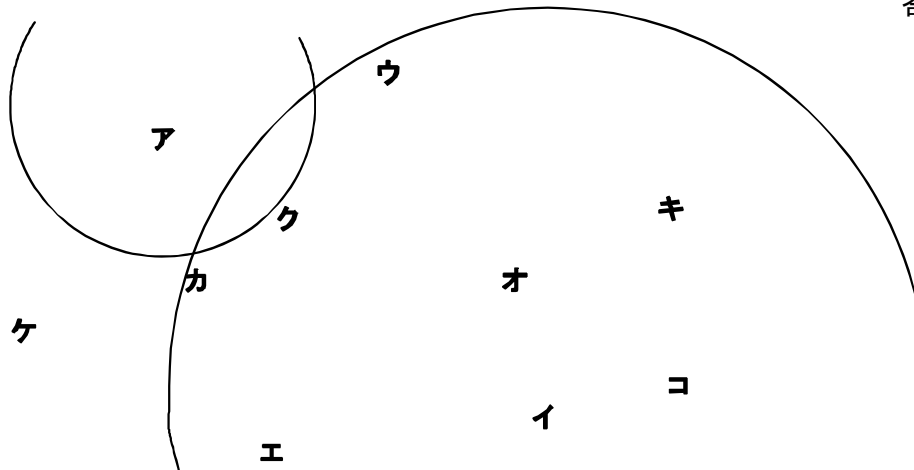

P. 19 円の利用 No. 4

1

答え (ク)

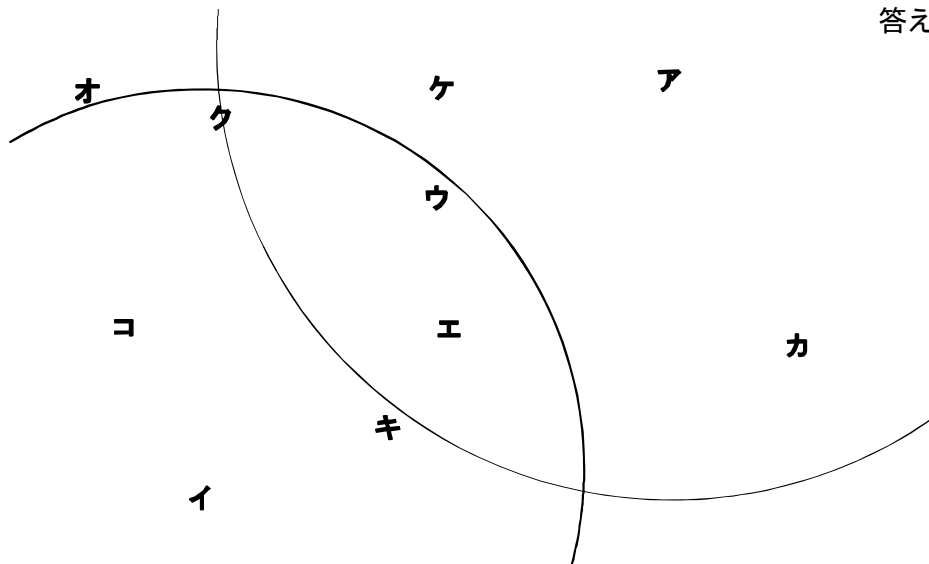

2

答え (コ)

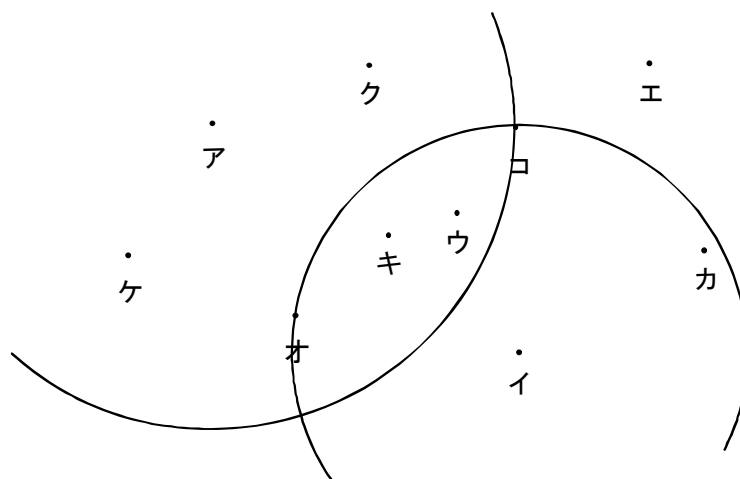

P. 20 球 No.1

1 答え (③, ④)

P. 21 球 No.2

1 答え (円)

2 ① (4cm) ② (10cm)

P. 22 球 No.3

1 ① (円) ② ア (直径) イ (中心) ③ (12cm)

④ (2cm)

2 ① (16cm) ② (7cm)

【まとめの問題】 第1回 (1/3)

1 ① (ア)(半径) (イ)(直径) (ウ)(中心) ② (2倍)

③ (イ) ④ (6cm) ⑤ (10cm)

【まとめの問題】 第1回 (2/3)

2 ① (円) ② (ア)(中心) (イ)(直径) ③ (5cm)

④ (8cm)

3 ①

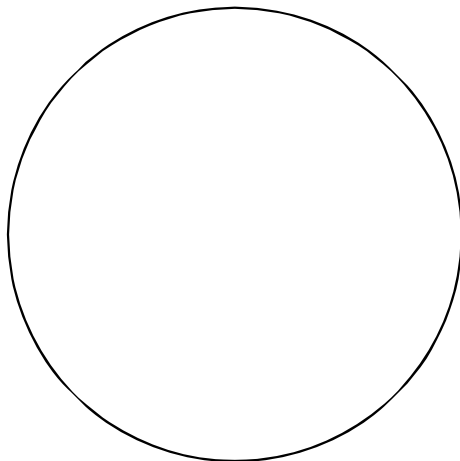

②

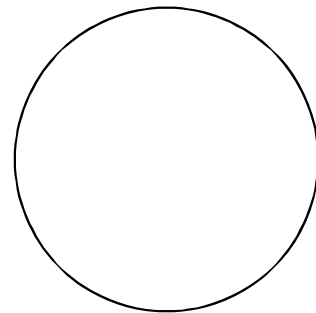

【まとめの問題】 第1回 (3/3)

4

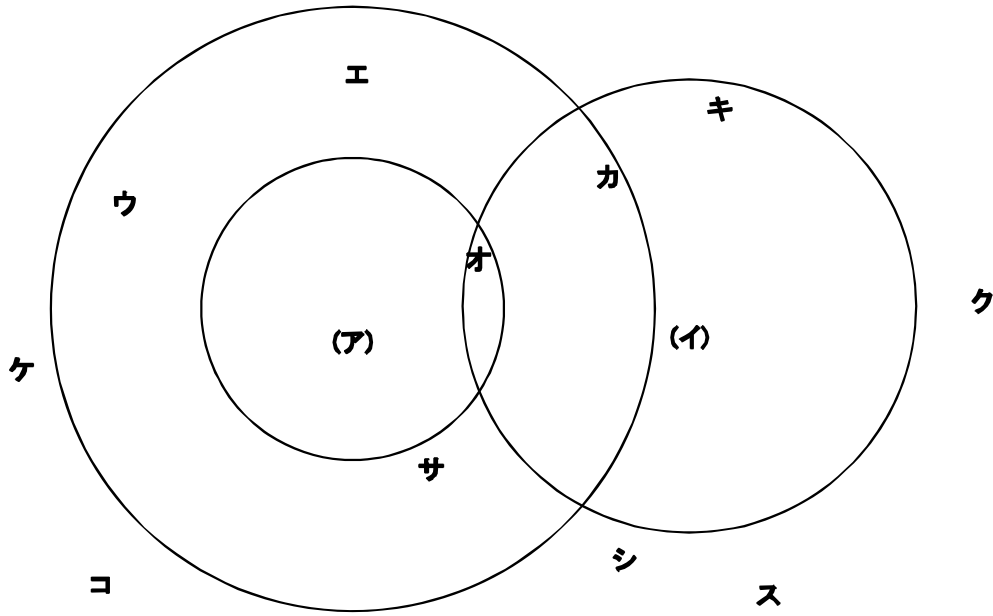

- ① (カ) ② (オ)

5

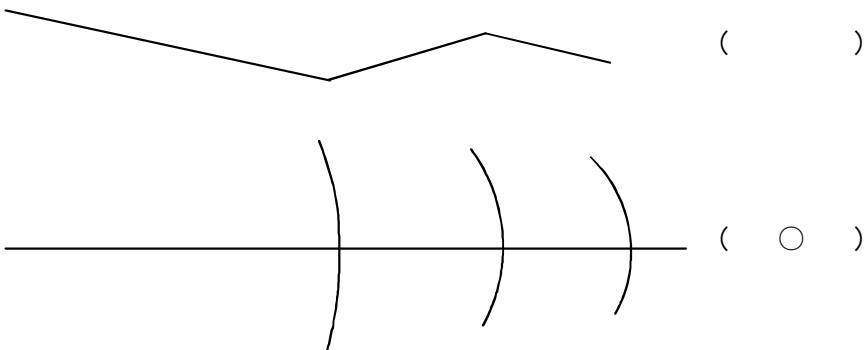

【まとめの問題】 第2回 (1/3)

1

- ① (ア) (直径) (イ) (半径) (ウ) (中心) ② (2倍)
 ③ (ア) ④ (8cm) ⑤ (8cm)

【まとめの問題】 第2回 (2/3)

- 2 ① (円) ② (ア)(中心) (イ)(直径) ③ (6cm)
 ④ (6cm)

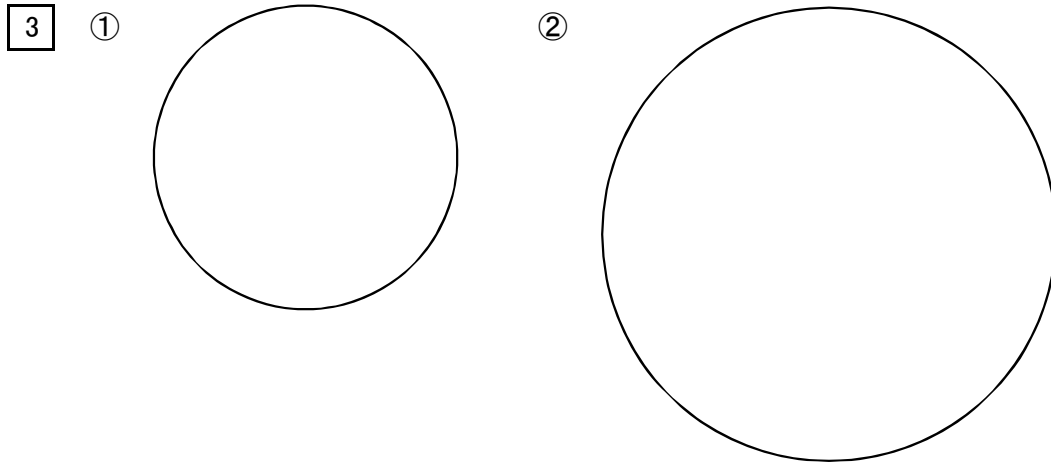

【まとめの問題】 第2回 (3/3)

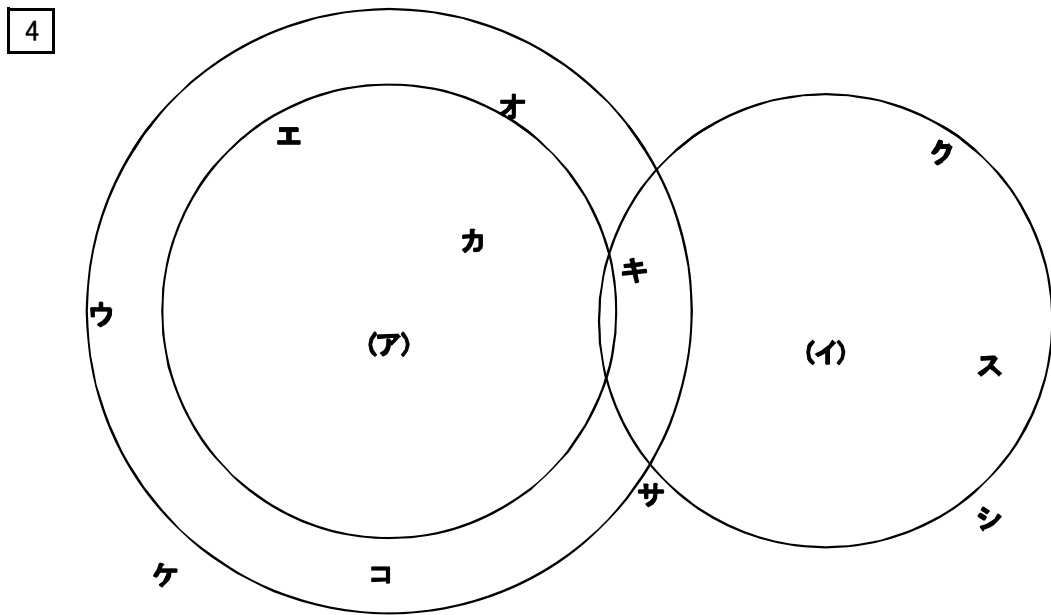

- ① (エとコ) ② (サ)

